



Demo Kit Manual

AS3935

Standard Board

AS3935 DK

Table of Contents

1	Features	3
1.1	Programmable Lightning Sensor AS3935 Key Features	3
2	Franklin Lightning Sensor Description	4
2.1	Board Description.....	4
2.2	Component Description Top	4
2.3	Component Description Bottom	4
2.4	Buzzer	5
2.5	LCD	5
2.6	Real Time Clock (RTC)	6
3	Lightning Emulator	7
3.1	Board Description.....	7
3.2	Lightning Emulator Description	7
3.3	LEDs	7
4	How to get started with Franklin Lightning Sensor Demo Kit	8
5	GUI Description.....	9
6	History Description	12
7	Layer Stack of Lightning Sensor	13
8	Layout Recommendations	13
9	Schematic, Layout and BOM of Lightning Sensor	14
9.1	Schematic of Lightning Sensor Demo Board.....	14
9.2	Board Layout of Lightning Sensor Demo Board	15
9.3	Bill of Material of Lightning Sensor Demo Board	16
10	Schematic, Layout and BOM of Lightning Emulator	17
10.1	Schematic of Lightning Emulator	17
10.2	Board Layout of Lightning Emulator.....	18
10.3	Bill of Material of Lightning Emulator	19
11	Ordering & Contact Information	20
12	Copyrights & Disclaimer.....	21
13	Revision Information	22

1 Features

- Fully operational Lightning Sensor
- Supplied by a 3V CR2032 battery with long battery life time >1000 hours
- Buzzer alarm for early warning of storm
- 128x32 display with blue backlight for detail information about storm warning
- Automatic antenna and RCO tuning implemented
- USB connection for adjusting AS3935 detail settings
- Handheld Lightning Emulator
- Emulation of lightning with different distance (far, close, closest) and noise generation

1.1 Programmable Lightning Sensor AS3935 Key Features

- Lightning Sensor warns of lightning storm activity within a radius of 40km
- Distance estimation to the head of the storm down to 1km
- Detects both cloud-to-ground and intra-cloud (cloud-to-cloud) flashes
- Embedded man-made disturber rejection algorithm
- Programmable detection levels enable threshold setting for optimal controls
- SPI and I²C interface is used for control and register reading
- Antenna tuning to compensate variations of the external components
- Supply voltage range 2.4V to 5.5V
- Power-down, listening, and active mode

2 Franklin Lightning Sensor Description

2.1 Board Description

Figure 1: Lightning Sensor – Top and Bottom view

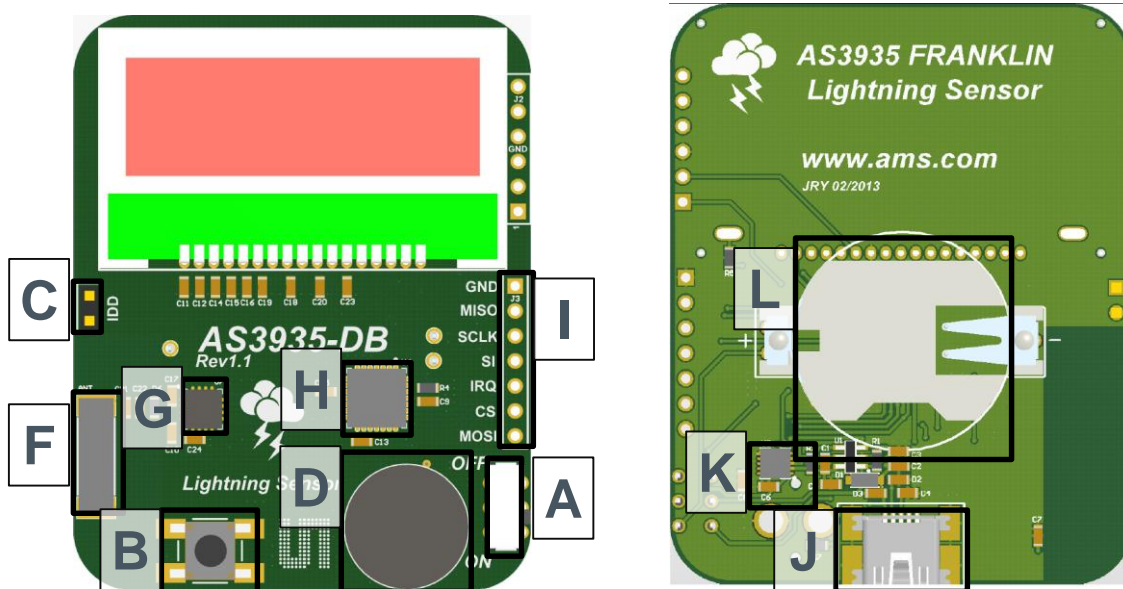

2.2 Component Description Top

Label	Name	Info
A	ON/OFF	Power on/off the Demo Board.
B	BUTTON	Short Press: The actual time of the RTC is shown. Long Press (>1s): The statistics of the AS3935 is cleared
C	IDD	IDD Jumper for current measurement of AS3935
D	BUZZER	Audio Information for Lightning and Disturber
E	LCD	128x32 Display, blue backlight
F	500kHz	100uH LF Antenna for AS3935
G	AS3935	Lightning Sensor
H	MCU	Microcontroller PIC24FJ64GB002
I	AS3935 Interface	SPI Interface to AS3935

2.3 Component Description Bottom





Label	Name	Info
J	USB-CONNECTOR	USB Interface for the GUI
K	AS1362, AS1746	Power Management; Analog Switch
L	CR2032 Battery	Insert CR2032 Coin Cell here



2.4 Buzzer

Label	Modulation	Info
D	1x500ms ON	Lightning detected
	2x150ms ON	Lightning detected: Distance to the previous lightning has changed
	4x50ms ON	Disturber detected

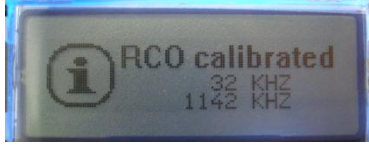
Note: The buzzer alarm can be modified or turned off via the GUI

2.5 LCD

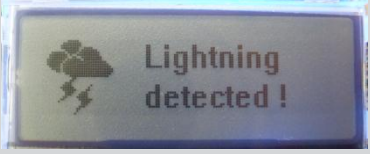
Label	Description	Sign
Booting	After power on of the demo board, the austriamicrosystems logo and the firmware version will be displayed.	
Antenna Tuning	After start-up the antenna of the AS3935 is automatically tuned. The tuning uses the internal array of capacitors to achieve 500kHz as resonance frequency. The resonance frequency and the internal capacitance are shown on the LCD.	
RCOs Calibration	After the antenna tuning the internal RC-Oscillators are calibrated. The SRCO is calibrated to 32kHz and the TRCO is calibrated to 1.1MHz. Both frequencies are displayed.	
USB connected	The demo board can be connected via USB. As soon as the USB bus is connected the sensor is turned off and all settings of the AS3935 can be saved in the GUI. If the demo board is power cycled when the USB plug is already connected, the LCO and RCO calibration is not executed, in order to allow the user to do those calibrations via the GUI.	
Listening Mode	After the calibration, the Lightning sensor is set in listening mode. No storm is within detection range.	

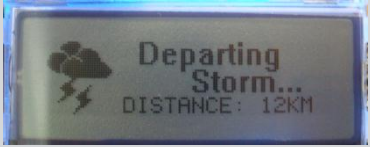
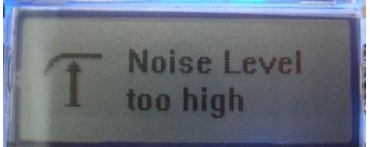
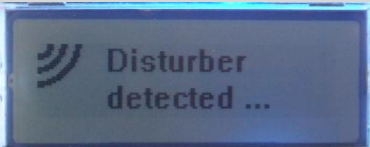
Label	Description	Sign
<p>Lightning</p>  <p>This symbol indicates a lightning – the text give further information.</p>	Lightning has been detected. The distance estimation and movement of the head of the storm is shown afterwards.	
	The distance to the head of the storm decreases.	
	The distance to the head of the storm increases.	
Noise Floor Detected	Continuous noise is jamming the AS3935 AFE; during this time the sensor cannot detect the presence of lightning activities.	
Disturber Detected	Disturbers have been received by the AS3935 and rejected by the disturber rejection embedded algorithm.	

2.6 Real Time Clock (RTC)

The demo board has a built in RTC that must be synchronized with a PC. Once the RTC is set to the current time, it is possible to create timestamps for detected lightning events. The synchronization via the GUI is explained in section **Error! Reference source not found.**

Note: The RTC is reset to midnight of 1. January 2012 and the history is cleared when the demo board is switched off and on again.

3 Lightning Emulator

3.1 Board Description

Figure 1: Lightning Emulator – Top and Bottom View

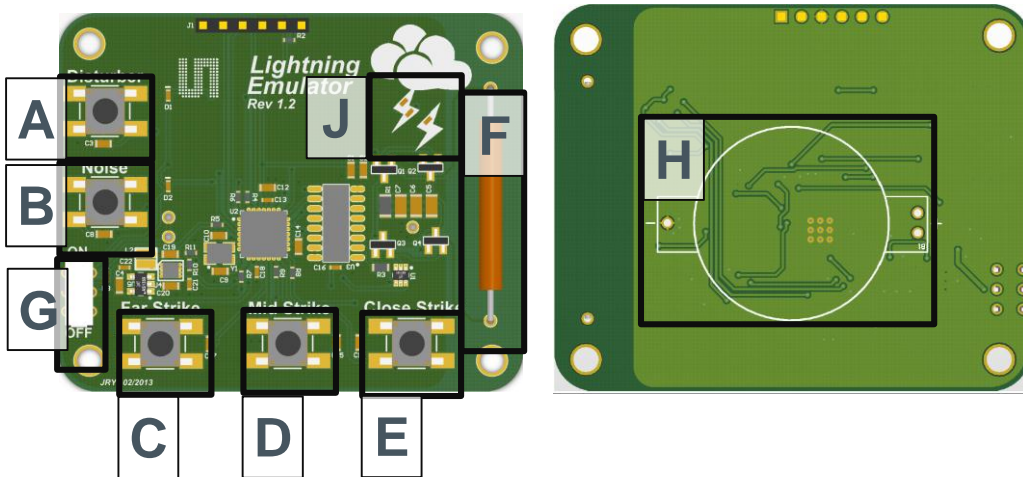

3.2 Lightning Emulator Description

Label	Name	Info
A	Disturber	Emulates a disturber on the antenna; red LED is flashing up
B	Noise	Emulates noise on the antenna; red LED keeps flashing as long as noise signals are emulated (3s)
C	Far Strike	Emulates a pattern of a lightning with far distance
D	Mid Strike	Emulates a pattern of a lightning with closer distance
E	Close Strike	Emulates a pattern of a lightning with the closest distance
F	Antenna	The different patterns are modulated on the 500kHz carrier that is transmitted via the LF antenna.
G	On/Off Switch	Turn both switches to ON to supply the lightning emulator; As soon as the demo board is switched on, the ON LED flashes up once a second to indicate being turned on.
H	Battery holder CR2450	The Lightning Emulator board is supplied with a CR2450 Coin Cell.

3.3 LEDs

Label	Name	Info
G	ON	Blue LED flashes up once a second
A	Disturber	Red LED flashes up in case a disturber is emulated
B	Noise	Red LED flashes up for 3s in case noise is emulated
J	Strike	Yellow LED flashes up in case far strike is emulated
		Orange LED flashes up in case mid strike is emulated

Label	Name	Info
		Red LED flashes up in case close strike is emulated

4 How to get started with Franklin Lightning Sensor Demo Kit

Due to the sensitive nature of the sensor towards noise and disturbers a separate application note is provided. It explains the operational environment and board placement for which the demonstration will work as intended. This information is given in the application note “AS3935_AppNote_AN03_DemoKit_Setup_EN_v1.pdf”.

- Insert the 3V battery (CR2032) in the battery holder “C” on the AS3935 demo board.
- Insert a 3V battery in the battery holder “G” on the Lightning Emulator.
- Position the lightning emulator and the AS3935 demo board in such a way that both antennas are in parallel to each other. Keep a distance of 10-15 cm between both boards.
- Turn on the AS3935 Lightning Sensor via the ON/OFF – switch “A”. When you switch on the board you will see on the LCD the austriamicrosystems logo followed by the LCO and the RCO calibration. After successful calibration the AS3935 goes into sense mode awaiting a lightning. **Note:** The LCO should be tuned to 500 kHz, the TRCO to 1.1 MHz and the SRCO to 32 kHz. To manually execute the tuning procedures connect the USB plug before turning the demo board on via switch “A”.
- Turn on the Lightning Emulator via the ON/OFF – switch “F”. When turned on, the blue LED will be continuously flashing. **Note:** Make sure the battery of the Lightning Emulator is full. Otherwise lightning might not be emulated correctly.
- Now you can start to press the switches “Far Strike”, “Mid Strike” and “Close Strike” (button “B”, “C”, and “D”) on the Emulator, simulating lightning events that will be detected by the sensor. The display will flash up showing the signs described above and the buzzer will trigger an alarm.
- If a disturber is emulated (button “A”) the AS3935 demo board will show “Disturber detected”.

5 GUI Description

Install the GUI and start the software. As soon as the demo board is connected the USB and AS3935 Symbol in the corner becomes green.

The LCD will show the USB connection and the sensor is turned off.

Figure 2: GUI of the AS3935 Lightning Sensor



The following parameters can be defined on the AS3935 Lightning Sensor:

- Power Down**
 In power down mode ($R0 < 0 \Rightarrow 1$), the entire AS3935 is switched off. The typical current consumption is 800nA. After power up, the TRCO is not calibrated. The calibration must be done by the user pressing the button “Calibrate RCOs”, and respectively “Calibrate LCO” if needed.
- LNA Settings**
 The LNA settings have to be changed according to the location of the lightning sensor (outdoor vs. indoor) as described in the AS3935 datasheet.
- Noise Floor**
 The threshold for the trigger of the noise floor interrupt can be selected via this drop down menu. A bigger value sets the threshold higher.

- Disturber**
 If the disturbers are masked, no interrupts will occur if a disturber is detected.
- Disturber Rejection Settings**
 With the watchdog threshold level WDTH (R1<3:0>) it is possible to increase the robustness to disturbers. The AS3935 is also capable of rejecting impulse signals, like spikes, picked up by the antenna. The spike rejection can be improved via the SREJ Level defined in R2<3:0>. By default, R2<3:0> = 0x2. Larger values of SREJ correspond to more robust spike rejection.
- Minimum Number of Strikes**
 It is possible to program the AS3935 to only issue lightning interrupts if a minimum number of lightning events are detected in a 15 minute time frame. This field allows setting it to 1, 5, 9 or 16 minimum numbers of lightning events. Once this threshold is reached the Lightning Sensor will display every further detected lightning event.
- Oscillators**
 In case the AS3935 demo board is connected to the GUI via USB before powering up the demo board, the oscillators will not be calibrated. The calibration procedure can be executed manually via the GUI. The first step is to measure the default resonance frequency of the oscillators by pressing “Measure”. The oscillators will show inaccurate values. Pressing “Calibrate LCO” will tune the antenna to 500 kHz, which will then allow the user to calibrate the RCOs by pressing “Calibrate RCOs”. The added tuning caps will be shown below. See the tuning sequence below:

Measure default values	Calibrate LCO	Calibrate RCOs

- Buzzer Control**
 The buzzer alarm can be modified for lightning only or can be completely turned off. The buzzer settings can be saved.
- Save Settings / Restore Default Settings**
 All settings of the AS3935 and the buzzer can be saved by pressing “Save Settings”. To reset the values to the factory settings press “Restore Default Settings”.
- Firmware Update**
 In order to update the firmware, open Help → Firmware Update (Ctrl+F) and select the new firmware revision.
- Show History**
 The history of the occurred strikes can be read out via the GUI and saved to a log file.
- Register Map**
 The entire register map can be readout via View→Register Map (Ctrl+M) and can be modified by clicking on the register entries.

Figure 3: Register Map

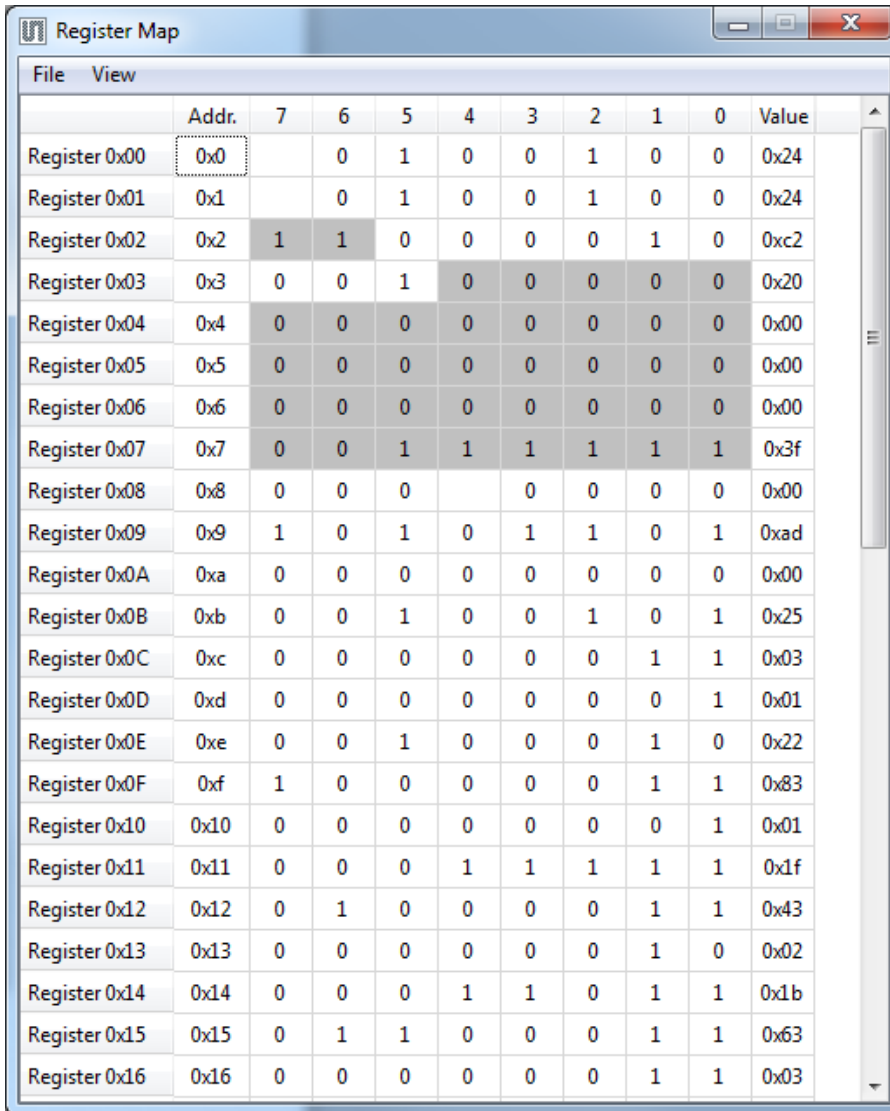

Register	Addr.	7	6	5	4	3	2	1	0	Value
Register 0x00	0x0		0	1	0	0	1	0	0	0x24
Register 0x01	0x1		0	1	0	0	1	0	0	0x24
Register 0x02	0x2	1	1	0	0	0	0	1	0	0xc2
Register 0x03	0x3	0	0	1	0	0	0	0	0	0x20
Register 0x04	0x4	0	0	0	0	0	0	0	0	0x00
Register 0x05	0x5	0	0	0	0	0	0	0	0	0x00
Register 0x06	0x6	0	0	0	0	0	0	0	0	0x00
Register 0x07	0x7	0	0	1	1	1	1	1	1	0x3f
Register 0x08	0x8	0	0	0		0	0	0	0	0x00
Register 0x09	0x9	1	0	1	0	1	1	0	1	0xad
Register 0x0A	0xa	0	0	0	0	0	0	0	0	0x00
Register 0x0B	0xb	0	0	1	0	0	1	0	1	0x25
Register 0x0C	0xc	0	0	0	0	0	0	1	1	0x03
Register 0x0D	0xd	0	0	0	0	0	0	0	1	0x01
Register 0x0E	0xe	0	0	1	0	0	0	1	0	0x22
Register 0x0F	0xf	1	0	0	0	0	0	1	1	0x83
Register 0x10	0x10	0	0	0	0	0	0	0	1	0x01
Register 0x11	0x11	0	0	0	1	1	1	1	1	0x1f
Register 0x12	0x12	0	1	0	0	0	0	1	1	0x43
Register 0x13	0x13	0	0	0	0	0	0	1	0	0x02
Register 0x14	0x14	0	0	0	1	1	0	1	1	0x1b
Register 0x15	0x15	0	1	1	0	0	0	1	1	0x63
Register 0x16	0x16	0	0	0	0	0	0	1	1	0x03

6 History Description

The demo board offers a volatile history that can be read out and its data can be saved into a log file.

Figure 4: Lightning History Window

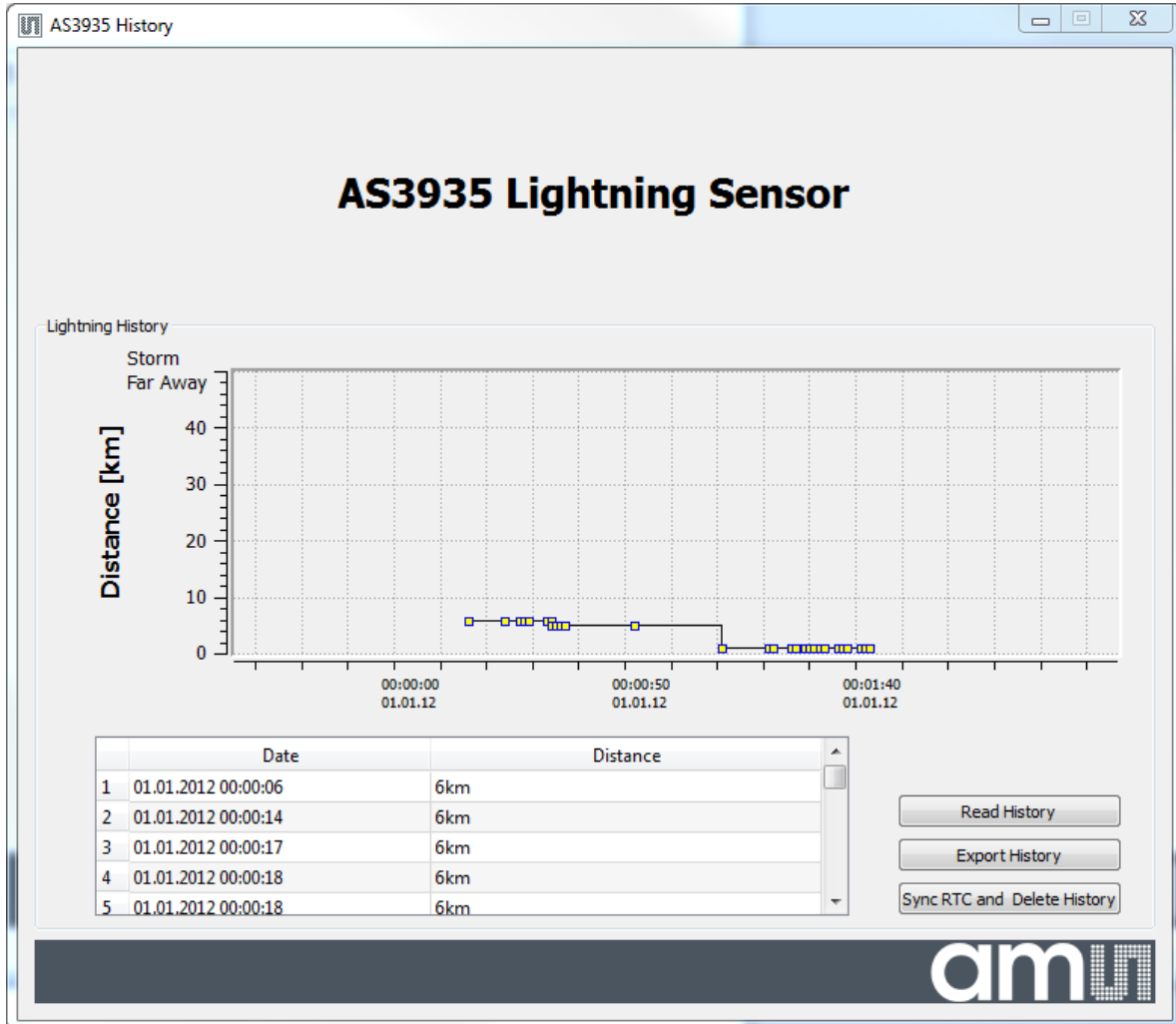

The history works as follows:

- It is possible to synchronize the RTC of the board with the time of your PC pressing “**Sync RTC and Delete History**”. The existing history in the memory is automatically deleted. A short pressing of the button "B" on the Lightning Sensor demo board shows the actual time on the LCD display.
Note: Right after every power up of the board the RTC is set to midnight of 1.January 2012. The history is deleted when the board is turned off.
- Each event detected by the Lightning Sensor is saved into the memory. It is possible to read out the history by connecting to the GUI and pressing the button “**Read History**”. The graph shows the estimated distance to the head of the storm over time.
- **Zoom into** the history by holding your left mouse button pressed.
- **Zoom out** of the history by pressing the right mouse button.
- Select some strikes in the graph and the details will be highlighted in the table below.

- All data can be exported into a log file by pressing **“Export History”**.

	A	B	C	D
1	AS3935 Lightning Sensor History			
2	Date [dd.mm.yyyy]	time [hh:mm:ss]	distance [km]	
3	25.04.2012	10:36:55	27	
4	25.04.2012	10:36:57	27	
5	25.04.2012	10:36:58	24	
6	25.04.2012	10:37:02	12	
7	25.04.2012	10:37:03	12	
8	25.04.2012	10:37:04	12	
9	25.04.2012	10:37:05	12	
10	25.04.2012	10:37:06	12	
11	25.04.2012	10:37:14	10	
12	25.04.2012	10:37:14	10	
13	25.04.2012	10:37:15	8	
14	25.04.2012	10:37:18	1	
15				

- It is possible to save a maximum of 190 lightning events in the memory. If the memory is full a notice will be displayed on the LCD to read out and delete the history. Please apply then **“Read History”**, **“Export History”** and **“Sync RTC and Delete History”**.

7 Layer Stack of Lightning Sensor

Figure 5: Layer Stack of PCB

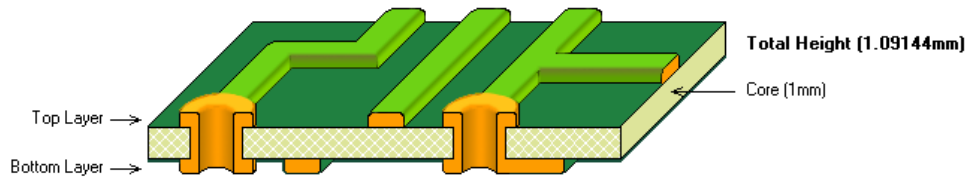

- PCB Material: FR4 1mm for Active Tag. FR4 1.6mm for base station
- 2 layer board
- Solder surface: chemical - tin
- Width of copper: 35µm
- Silk screen top/bottom: white

8 Layout Recommendations

- Do not cross the SPI lines with the sensitive inputs of the antenna.
- Below the 500 kHz LF antenna there should not be a GND plane.
- Make sure that the GND plane is routed carefully.
- Do not run SPI or any other interface on 500 kHz clock speed, in order to avoid cross-coupling.

9 Schematic, Layout and BOM of Lightning Sensor

9.1 Schematic of Lightning Sensor Demo Board

Figure 6: Board Schematics of Lightning Sensor Demo Board

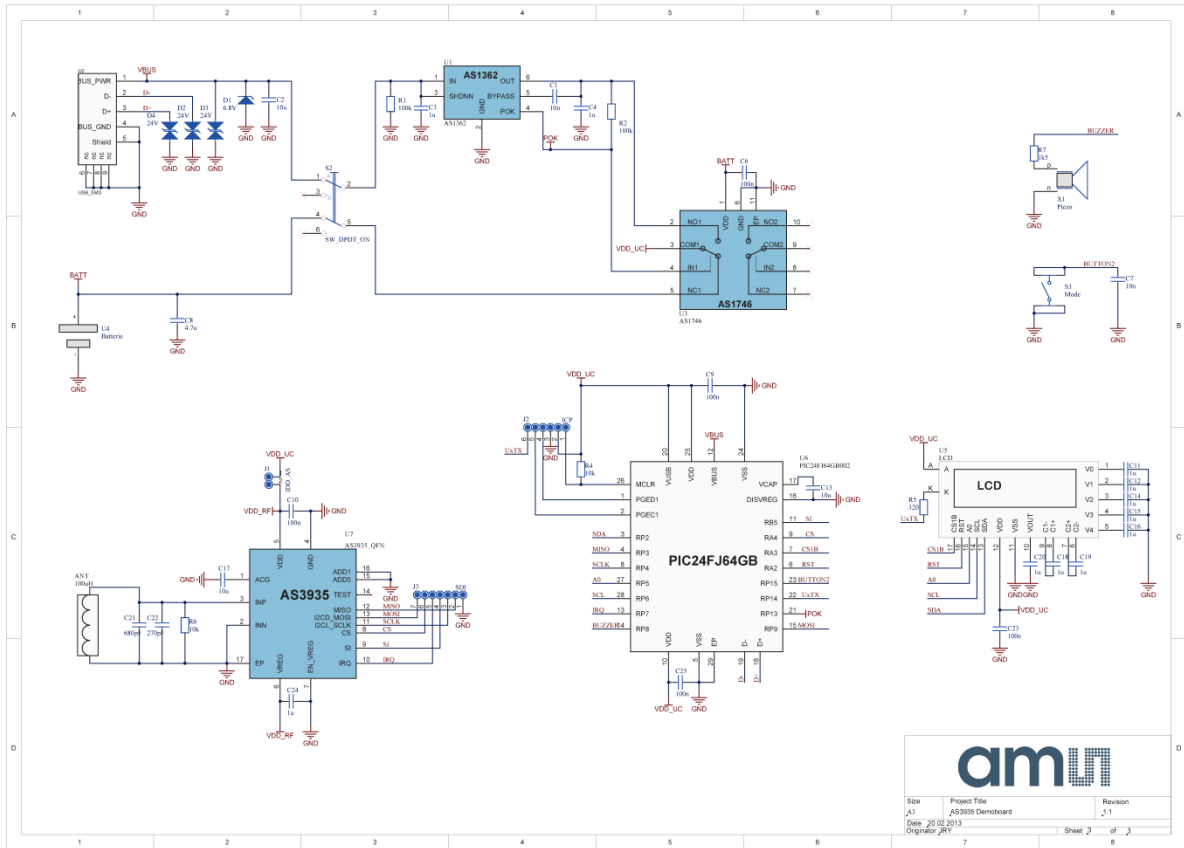

9.2 Board Layout of Lightning Sensor Demo Board

Figure 7: Top Layer

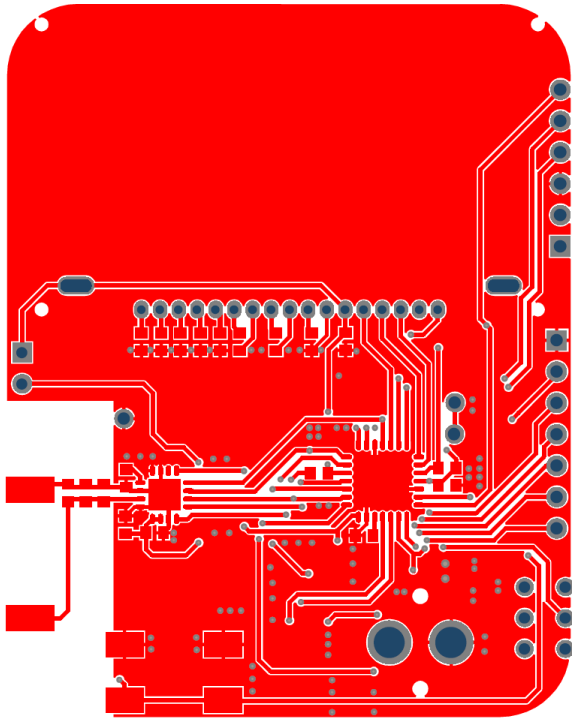
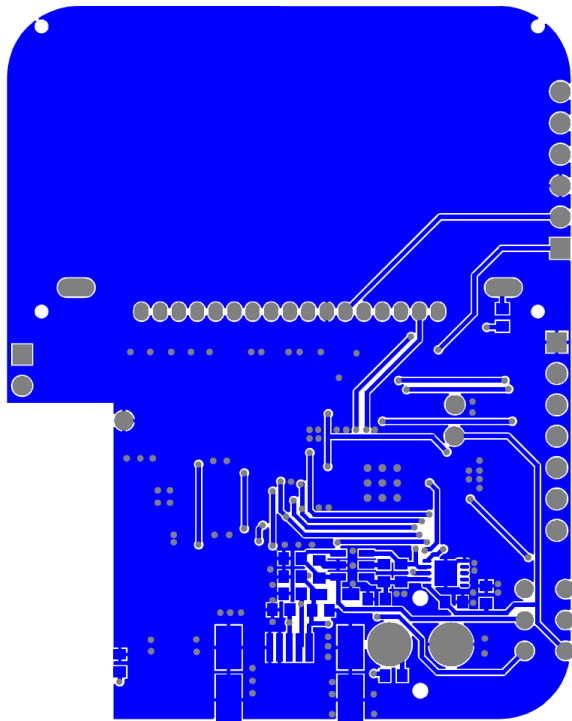

Figure 8: Bottom Layer



9.3 Bill of Material of Lightning Sensor Demo Board

Bill of Materials			AS3935 Demoboard			
Company:			ams AG			
Originator:			JRY			
PCB Name:			AS3935 Demoboard			
PCB Version:			1.1			
Report Date:			20.02.2013			
#	Designator	Comment	Component Description	Manufacturer	Manufacturer Part Number	Quantity
1	ANT	100uH	100uH, Q=34	Coilcraft	MASS32-AE	1
2	C1, C7	10n	0603	AVX	06033C103KAT2A	2
3	C2, C13, C17	10u	TDK - C1608X5R0J106M -	TDK	C1608X5R0J106M	3
4	C3, C4, C11, C12, C14, C15,	1u	KEMET -	KEMET	C0603C105K9RACTU	11
5	C6, C9, C10, C23, C25	100n	0603	AVX	0603YC104KAT2A	5
6	C8	4.7u	CAP CER 4.7UF 6.3V X5R	Taiyo Yuden	JMK107BJ475MA-T	1
7	C21	680pF	MULTICOMP - MCCA000975	MULTICOMP	MCCA000975	1
8	C22	270pF	CAP CER 270PF 25V 1%	AVX Corporation	06033A271FAT2A	1
9	D1	6.8V	ON SEMICONDUCTOR -	ON SEMICONDUCTOR	MM3Z6V8T1G	1
10	D2, D3, D4	24V	COOPER BUSSMANN -	COOPER BUSSMANN	0603ESDA-TR1	3
11	J1	IDD_AS	2 pole pin header			1
12	J2	ICP	not assembled			1
13	J3	SDI	not assembled			1
14	R1, R2	100k	0603	VISHAY DRALORIC	CRCW0603100KFKEA	2
15	R4, R6	10k	0603	VISHAY DRALORIC	CRCW060310K0FKEA	2
16	R5	320	0603	Vishay Thin Film	PAT0603E3200BST1	1
17	R7	1k5	0603	MULTICOMP	MC 0.063W 0603 5% 1K5	1
18	S2	SW_DPDT_ON	SW SLIDE DPDT 6VDC 0.3A	C&K Components	JS202011AQN	1
19	S3	Mmode	TE CONNECTIVITY /	TE CONNECTIVITY /	FSM2JSMA	1
20	U1	AS1362	IC Reg LDO 3.0V 0.3A	ams	AS1362-BTTT-30	1
21	U2	USB_SMD	CONN RECEPT USB SPOS	Molex Connector	56579-0576	1
22	U3	AS1746	IC Switch Dual SPDT 10-	ams	AS1746-BTDR	1
23	U4	Batterie	RENATA - HU2032-LF - THT	RENATA	HU2032-LF	1
24	U5	LCD	LCD COG GRAPH 128X32	Newhaven Display Intl	NHD-C12832A1Z-FSB-FBW-3V3	1
25	U6	PIC24FJ64GB002	MICROCHIP -	MICROCHIP	PIC24FJ64GB002-IML	1
26	U7	AS3935_QFN	IC Sensor Lightning	ams	AS3935-BQFT	1
27	X1	Piezo	BUZZER PIEZO 30VP-P	Murata Electronics North	PKM13EPYH4002-B0	1
Approved			Notes			48

10 Schematic, Layout and BOM of Lightning Emulator

10.1 Schematic of Lightning Emulator

Figure 9: Board Schematics of Lightning Emulator

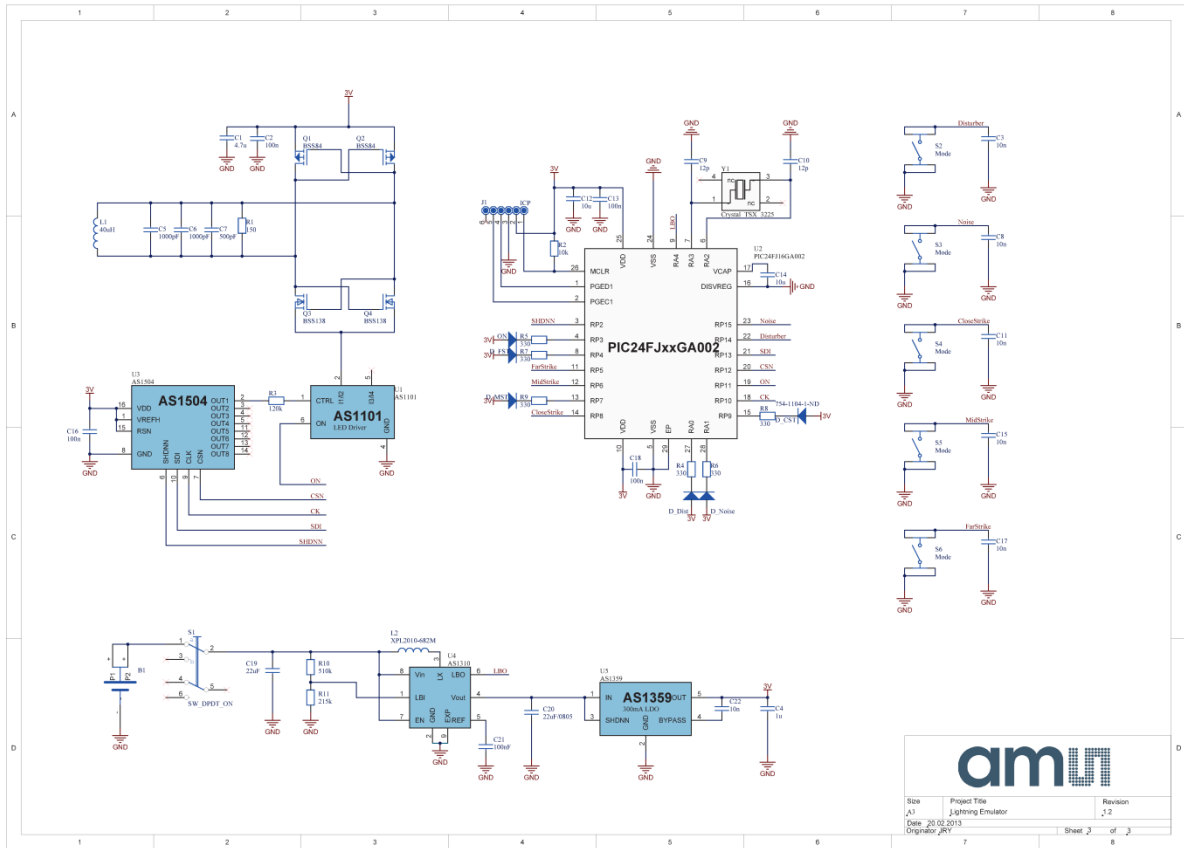

10.2 Board Layout of Lightning Emulator

Figure 10: Top Layer

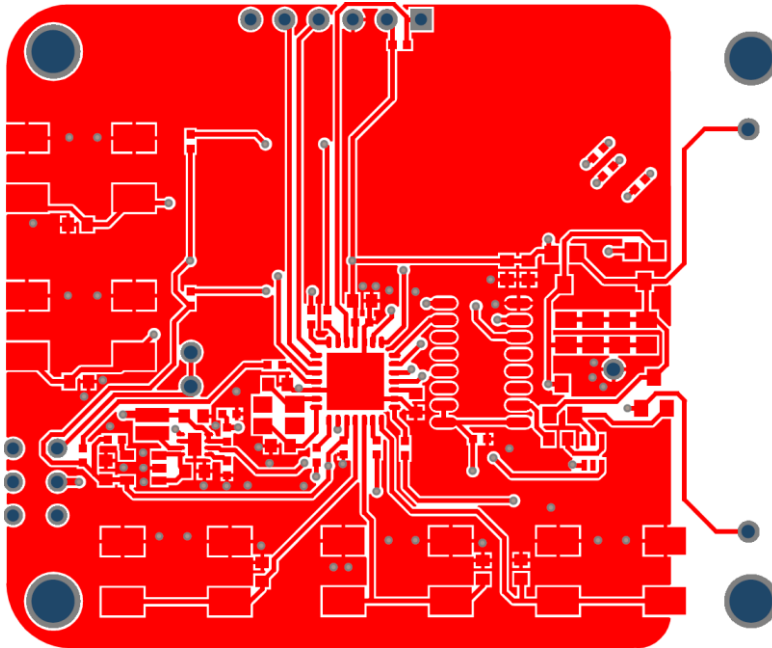
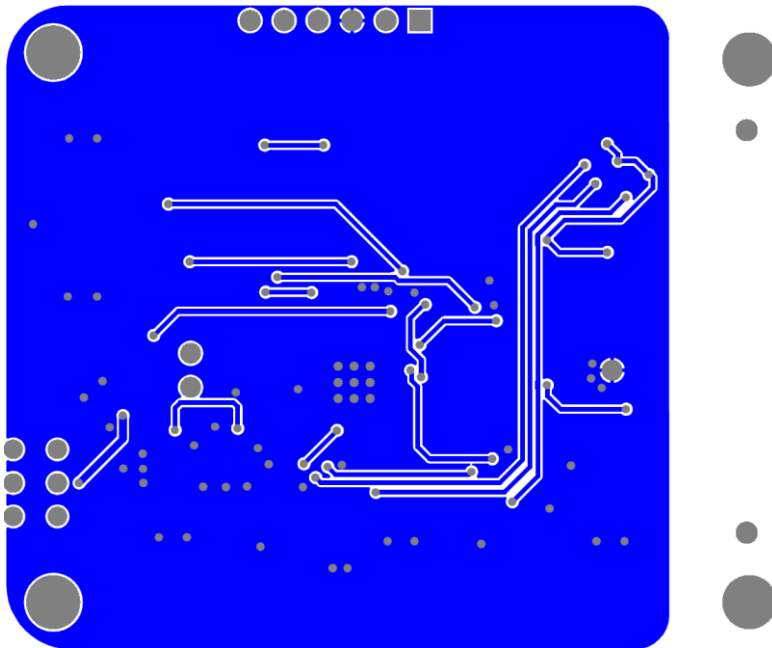

Figure 11: Bottom Layer



10.3 Bill of Material of Lightning Emulator

Bill of Materials			Lightning Emulator			
Company:			ams AG			
Originator:			JRY			
PCB Name:			Lightning Emulator			
PCB Version:			1.2			
Report Date:			20.02.2013			
#	Designator	Comment	Component_Description	Manufacturer	Manufacturer Part Number	Quantity
1	B1	Battery_Holder_3pin_THMD		Renata	HU2450N-LF	1
2	C1	4.7u	0603			1
3	C2, C13, C16, C18	100n	0402, 0603			4
4	C3, C8, C11, C15, C17, C22	10n	0603, MURATA -	MURATA	GRM188R71C104KA01D	6
5	C4	1u	CAP CER 4.7UF 6.3V XSR	Taiyo Yuden	JMK107BJ475MA-T	1
6	C5, C6	1000pF	VISHAY VITRAMON -	VISHAY VITRAMON	VJ0805A102JXBMT	2
7	C7	500pF	AVX - 0805SA511JAT2A -	AVX	0805SA511JAT2A	1
8	C9, C10	12p	0603			2
9	C12, C14	10u	0603			2
10	C19	22uF	MURATA -	MURATA	GRM21BR60J226ME39L	1
11	C20	22uF/0805	MURATA -	MURATA	GRM21BR60J226ME39L	1
12	C21	100nF	MURATA -	MURATA	GRM188R71C104KA01D	1
13	D1	D_Dist	LED 1X0.5MM 630NM RD	Kingbright Corp	APHHS1005SURCK	1
14	D2	D_Noise	LED 1X0.5MM 630NM RD	Kingbright Corp	APHHS1005SURCK	1
15	D3	ON	LED 1X0.5MM 470NM BL	Kingbright Corp	APHHS1005PBCA	1
16	D4	D_FST	LED 1X0.5MM 590NM YW	Kingbright Corp	APHHS1005SYCK	1
17	D5	D_MST	LED 1X0.5MM 601NM ORN	Kingbright Corp	APHHS1005SECK	1
18	D6	D_CST	LED 1X0.5MM 630NM RD	Kingbright Corp	APHHS1005SURCK	1
19	J1	ICP	not assembled			1
20	L1	40uH	EPCOS - B82111EC23 -	EPCOS	B82111EC23	1
21	L2	XPL2010-682M	COILCRAFT- XPL2010-	Coilcraft	XPL2010-682M	1
22	Q1, Q2	BSS84	FAIRCHILD	FAIRCHILD	BSS84	2
23	Q3, Q4	BSS138	FAIRCHILD	FAIRCHILD	BSS138	2
24	R1	150	0805			1
25	R2	10k	0402			1
26	R3	120k	0603			1
27	R4, R5, R6, R7, R8, R9	330	PANASONIC -	PANASONIC	ERJ2GEJ331X	6
28	S1	SW_DPDT_ON	SW SLIDE DPDT 6VDC 0.3A	C&K Components	JS202011AQN	1
29	S2, S3, S4, S5, S6	Mode	TE CONNECTIVITY /	TE CONNECTIVITY /	FSM2J5MA	5
30	U1	AS1101	Dual LED driver with enable	ams	AS1101-T	1
31	U2	PIC24FJ16GA002	IC PIC MCU FLASH 16K 28-	Microchip Technology	PIC24FJ16GA002-VML	1
32	U3	AS1504	Octal 8-bit DAC, Mid-Scale	ams	AS1504-T	1
33	U4	AS1310	Ultra Low Quiescent	ams	AS1310_BTDT-33	1
34	U5	AS1359	Ultra Low-Noise 300mA	ams	AS1395-BTTT-31	1
35	Y1	Crystal_TSX_3225		EPSON TOYOCOM	TSX-3225, 16MHZ, 10PPM, 9PF	1
Approved			Notes			57

11 Ordering & Contact Information

Ordering Code	Description
AS3935 DK	AS3935 Demo Kit Standard Board

Buy our products or get free samples online at:

www.ams.com/ICdirect

Technical Support is available at:

www.ams.com/Technical-Support

Provide feedback about this document at:

www.ams.com/Document-Feedback

For further information and requests, e-mail us at:

ams_sales@ams.com

For sales offices, distributors and representatives, please visit:

www.ams.com/contact

Headquarters

ams AG

Tobelbaderstrasse 30

8141 Unterpemstaetten

Austria, Europe

Tel: +43 (0) 3136 500 0

Website: www.ams.com

12 Copyrights & Disclaimer

Copyright ams AG, Tobelbader Strasse 30, 8141 Unterpremstaetten, Austria-Europe. Trademarks Registered. All rights reserved. The material herein may not be reproduced, adapted, merged, translated, stored, or used without the prior written consent of the copyright owner.

Demo Kits, Evaluation Kits and Reference Designs are provided to recipient on an “as is” basis for demonstration and evaluation purposes only and are not considered to be finished end-products intended and fit for general consumer use, commercial applications and applications with special requirements such as but not limited to medical equipment or automotive applications. Demo Kits, Evaluation Kits and Reference Designs have not been tested for compliance with electromagnetic compatibility (EMC) standards and directives, unless otherwise specified. Demo Kits, Evaluation Kits and Reference Designs shall be used by qualified personnel only.

ams AG reserves the right to change functionality and price of Demo Kits, Evaluation Kits and Reference Designs at any time and without notice.

Any express or implied warranties, including, but not limited to the implied warranties of merchantability and fitness for a particular purpose are disclaimed. Any claims and demands and any direct, indirect, incidental, special, exemplary or consequential damages arising from the inadequacy of the provided Demo Kits, Evaluation Kits and Reference Designs or incurred losses of any kind (e.g. loss of use, data or profits or business interruption however caused) as a consequence of their use are excluded.

ams AG shall not be liable to recipient or any third party for any damages, including but not limited to personal injury, property damage, loss of profits, loss of use, interruption of business or indirect, special, incidental or consequential damages, of any kind, in connection with or arising out of the furnishing, performance or use of the technical data herein. No obligation or liability to recipient or any third party shall arise or flow out of ams AG rendering of technical or other services.

Note: This product is intended to be used as an early warning indicator for lightning related storms. It does not guarantee accuracy or predict exact strike locations. By using the part, the user shall be aware that he cannot just rely on the indication in order to prevent accidents caused by lightning strikes. ams expressly states that the user must follow the generally known and recommended instructions how to behave in the event of lightning strikes. In no event shall ams or its suppliers be liable for any direct, indirect, incidental, special, exemplary or consequential damages (including, but not limited to procurement of substitute goods or services, loss of use, data or profits, or business interruption) arising out of user’s disregarding of such warnings and instructions.